

Solatube® Light Add-on Kit Installation Instructions

Required By UL

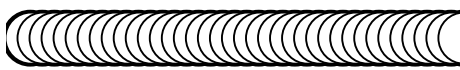

#9 Flexible Conduit

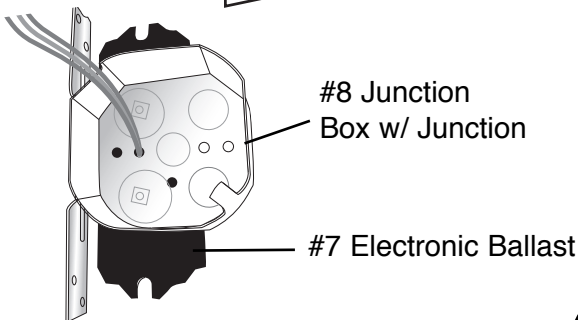
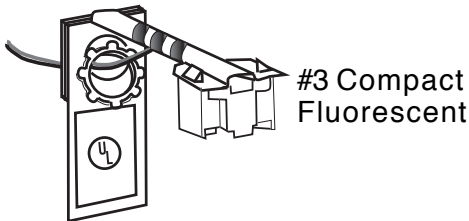
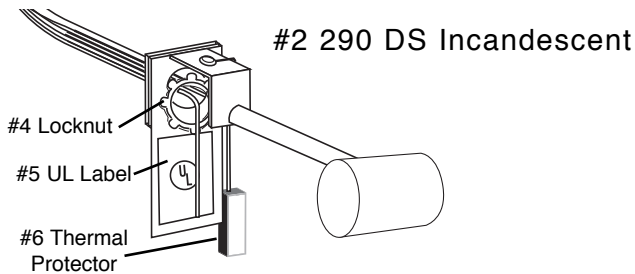
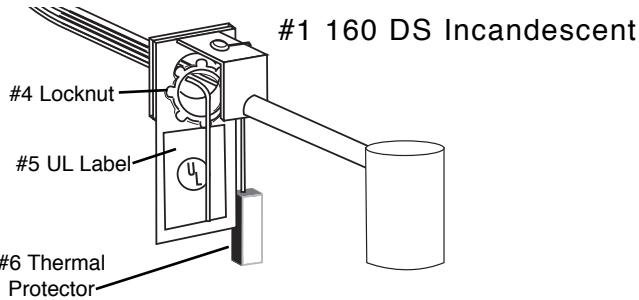
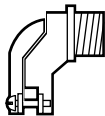

#10 Conduit Connector (90°)



#11 Anti-Short Bushing

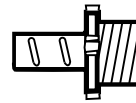

#12 Conduit Connector (Straight)



#13 Wire Connecting Nuts



#14 Ground Wire Crimp Sleeve



#15 Ground Screw

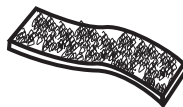

#16 Foam Seal

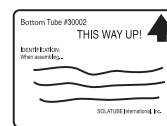

#17 Bottom-Tube Identity label



OPTIONAL PART

#18 Fluorescent Lamp (GX24q-3 Base, 26W 4-Pin)

PARTS LIST

PART #	DESCRIPTION	QUANTITY
ASSEMBLY		
1	160 DS Assembled Incandescent Lampholder & Wires	1
2	290 DS Assembled Incandescent Twin Lampholder & Wires	1
3	Assembled Compact Fluorescent (for use with 160 DS and 290 DS)	1
COMPONENTS WITHIN ASSEMBLY		
4	Connector Locknut	1
5	UL Label	1
6	Thermal Protection Device (TPD)	1
7	Electronic Ballast (Pre-Assembled)	1
8	Junction Box with Cover	1
(#7 and 8 apply to Compact Fluorescent only)		
FASTENER PARTS-BAGGED		
9	Flexible Conduit 3/8" (9 mm)	1
10	Conduit Connector 3/8" (9 mm), 90°	1
11	Anti-Short Bushing (ASB) (Red)	1
12	Conduit Connector 3/8" (9 mm) Straight	1
13	Wire Connecting Nuts (Orange)	4
14	Ground Wire Crimp Sleeve (Copper)	1
15	Ground Screw	1
16	Foam Seal 1/8" x 3/4" x 4" (19 x 100mm)	1
17	Bottom Tube Identity Label	1
OPTIONAL PARTS		
18	Fluorescent Lamp (GX24q-3 Base, 26W 4-Pin)	

For the most current Installation Instructions, please visit www.solatube.com/instructions



WARNING



Do not proceed with the installation until you have read the entire instructions, including these warnings.

Solatube International (seller) assumes no responsibility or obligation whatsoever for the failure of an architect, contractor, installer, or building owner to comply with all applicable laws, ordinances, building codes, energy codes, fire and safety codes and requirements, and adequate safety precautions. Installation of this product should be attempted only by individuals skilled in the use of the tools and equipment necessary for installation. Protect yourself and all persons and property during installation. If you have any doubt concerning your competence or expertise, consult a qualified expert before proceeding.

Install at your own risk!

Solatube product installations may be dangerous and include the potential for death, personal injury and property damage. The hazardous conditions include but are not limited to the following:

- **During installation, the Solatube Daylighting System's reflective tubes may focus sunlight, causing intense heat or fire. Remove protective film only after the parts have been installed. Prior to and during installation, do not leave tubes in contact with combustible materials or unattended, especially near direct sunlight. Avoid skin burns.**
- Sheet metal edges may be sharp. Use protective gloves to avoid lacerations.
- Solatube Daylighting System installations require climbing and working at dangerous heights, including on ladders, scaffolding, roofs and in attic spaces. Risk of death, personal injury and property injury may result from a fall, or from falling objects. Use extreme caution to minimize risk of accidental injury, including, but not limited to the following procedures:
 - Clear area below your work space of all people, animals and other items.
 - Avoid working on surfaces that are slippery or wet.
 - Use foot-wear with excellent traction.
 - Use only strong, well supported ladders.
 - Work only in calm dry weather.
 - When in the attic, ensure that your weight is supported at all times with structurally sound framing; dry wall material is not designed to carry a person's weight.
- To reduce the risk of fire, electric shock, and personal injury; basic safety precautions should always be followed when using electric tools, including always wearing safety goggles or other suitable eye protection, and ensuring work area is clear of all electrical wires, gas pipes, water pipes, and other obstacles.
- When working in the attic or other dusty areas, use of a mask or respirator is recommended to avoid lung irritation. Attic spaces may be dark, confined, and subject to extreme temperatures. Beware of sharp protruding objects. Do not attempt installation without having someone within range of your voice or close enough to come to your aid if necessary.

WARNING

1. Risk of fire and electric shock. Most dwellings built before 1985 have supply wire rated 60°C. This product is to be installed by qualified electricians only.
2. To reduce the risk of fire, use only:
 - 1) Incandescent Lamps Type A19 and T19; 100 Watt Maximum
 - 2) Fluorescent Lamps, Medium Base - 20 Watt Maximum
 - 3) Compact Fluorescent (4 Pin Quad Tube) 26 Watt only
 - 4) To reduce the risk of shock, disconnect power before installation or service.

Caution: Before beginning installation, understand the following:

1. Read through installation instructions. Follow all electrical codes, building codes, and the specific requirements within your jurisdiction.
2. Thermally Protected Type IC (insulation may contact housing).
3. Intended for installation with 1/2" (12.7mm) minimum spacings from the fixture to cavity surfaces (side wall and overhead building member) and 1" (25.4mm) minimum spacings to adjacent fixtures.
4. Suitable for wet and damp locations such as laundry, bathroom and shower stall. Must use GFCI circuit if located within a bath/shower stall. Use only as a component of Solatube Daylighting System products including bathroom ventilators.

SPECIFICATIONS: Light Add-On Kit - 160 DS Incandescent, 290 DS Incandescent, Compact Fluorescent

Fixture:	Recessed Incandescent Compact Fluorescent - Thermally Protected Type IC. Suitable for wet conditions.		
Supply:	120volt - 60Hz		
Amps:	160 DS Incandescent-.83	290 DS Incandescent- 1.66 Amp	Compact Fluorescent-.46 Amp
Cycle:	60 Cycle	60 Cycle	60 Cycle
Bulb:	Incandescent Lamp - 100 Watt Maximum or 20 Watt Maximum Fluorescent Lamp Medium Base Compact Fluorescent Lamp - use GX24q-3 Base, 26W 4-Pin only		

- Installation:
- 1) To be installed by qualified electricians only.
 - 2) Disconnect power before installation.
 - 3) For supply connections, use wire rated at least 60°C.
 - 4) Access above ceiling to Junction Box is required.
 - 5) Blinking light may indicate improper lamp wattage or type, or insulation too close to fixture, or other condition causing overheating.
 - 6) 160 DS Incandescent or Compact Fluorescent Light Add-On Kit to be used only as a component of Solatube 160 DS or Ventilation Add-On Kit.
 - 7) 290 DS Incandescent or Compact Fluorescent Light Add-On Kit to be used only as a component of Solatube 290 DS.

- Application:
- 1) Suitable for wet locations.
- Consideration:
- 2) Must use GFCI (Ground Fault Circuit Interrupter) if serviceable from bath or shower stall.
 - 3) You may add the 160 DS Light Add-On Kits or 290 DS Light Add-On Kit to an existing switch circuit.
 - 4) Type IC - NOTE: Bottom tube housing, "finishing section", may contact insulation.

Diagram A

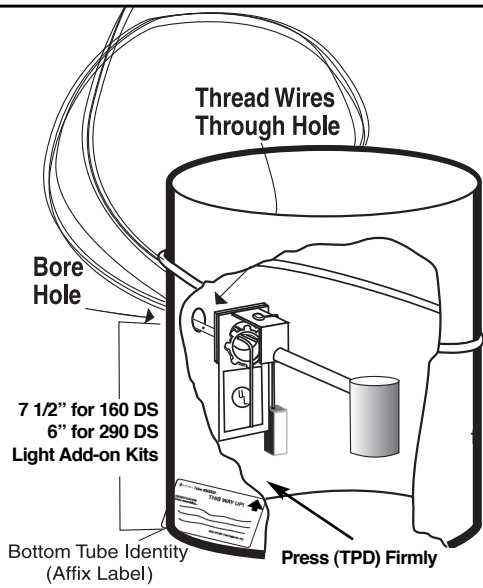

ASSEMBLY

LAMP BRACKET-LOCATION

Step 1. Follow Solatube Brighten Up® Series standard instructions to assemble the Bottom Tube and ceiling ring. Using a spur bit, bore a 7/8" (22.2mm) diameter hole through the tube wall, located 7 1/2" (190mm) for 160 DS Add-On Kits or 6" (152mm) for 290 DS Add-On Kits up from the bottom of the Bottom Tube.

WARNING: DO NOT MODIFY LOCATION. ALTERATION OF DISTANCE SPECIFIED VOIDS WARRANTY AND IMPAIRS SAFE TEMPERATURE PERFORMANCE.

Peel the backing paper off the Bottom Tube identity label. Apply the label 1" (2.5mm) from the bottom, to the outer surface (the nonreflective surface) of the Bottom Tube (**Diagram A**).

LAMP BRACKET-HOUSING ASSEMBLY

Step 2. Peel protective liner from the Bottom Tube prior to attaching the lamp bracket. Thread the wires out through the 7/8" (22.2mm) hole in the tube, then through 90° conduit connector (**Diagram A**). Push the connector through the tube wall and lamp bracket. For 160 DS Add-On Kit: Adjust the bracket and single lampholder to face down (**Diagram A**). For 290 DS Add-On Kit: Adjust the bracket and twin lamp holder so that the lamp sockets face the sides of the tube (**Diagram B**). For Compact Fluorescent Add-On Kit: Adjust the bracket and single lamp holder to face down (**Diagram C**). Turn the connector to face the junction box and secure it with the connector locknut (min 2 threads) (**Diagram B**). Remove the cap from the back of the 90° connector and wrap the foam seal around the wires. Using a slotted screwdriver, push the foam into the connector to form a dust seal. Replace the cap (**Diagram B**).

Diagram B

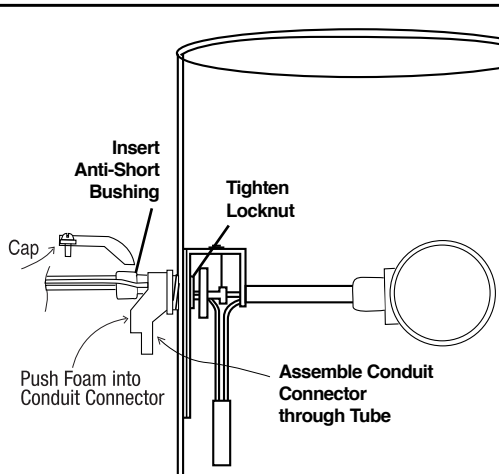

THERMAL PROTECTION DEVICE

Step 3. Peel the backing paper off of the thermal protection device (TPD). Do not touch adhesive or stretch the wires. Press the TPD firmly onto the tube wall off to one side of the lamp bracket approximately 3" (76mm) below the 7/8" (22.2mm) hole (**Diagram A**).

Diagram C

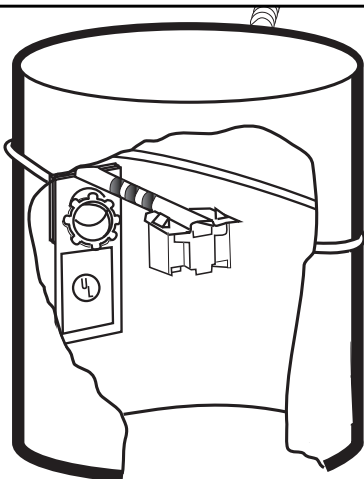

CONDUIT/JUNCTION BOX ASSEMBLY

Step 4. Feed the wires through the flexible conduit. Insert the anti-short bushing (ASB) over the wires between the conduit and the 90° connector so the cone of the ASB enters the conduit (**Diagram B**).

Fit the conduit into the 90° connector and tighten screws. At opposite end of conduit, push the exposed wires through the straight connector and screw connector into the conduit. Feed wires into junction box, then fasten conduit connector to box with connector locknut (**Diagram D**). **Junction box not provided- can obtain at local hardware store.** An electronic ballast pre-assembled to a junction box with cover is provided with Compact Fluorescent Add-On Kit only.

INSTALLATION

Step 5. Complete Solatube Brighten Up Series standard instructions to install the Bottom Tube in the ceiling.

WIRING

ALL WIRING MUST COMPLY WITH LOCAL CODES, BE PROPERLY GROUNDED, AND JUNCTION BOX MUST BE ACCESSIBLE ABOVE CEILING. DISCONNECT POWER BEFORE PROCEEDING.

Step 6. Feed (hot) wire of 120 volt AC supply cable (with ground) through a switch then connect the cable to junction box. Bond the supply ground wire to the junction box with #10 ground screw provided. Leave 6" pigtail for fixture ground wire connection.

(Diagram E) 160 DS Incandescent or 290 DS Incandescent Light Add-On Kit

Step 7a. Follow the wiring diagram shown in Diagram E. Using the ground crimp sleeve provided, connect the fixture ground wire to the supply ground wire. Using wire nuts provided, connect the black fixture wire to the hot supply wire and connect the white fixture wire to the common supply wire. Install cover on junction box.

Compact Fluorescent Light Kit.

Step 7b. Follow the appropriate wiring diagram for light only or fan/light combination as shown in (Diagram F). Using ground crimp sleeve provided, connect fixture ground wire to supply ground wire pigtail. Using wire nuts provided connect each black fixture wire to each red ballast wire and each white fixture wire to each blue ballast wire.

Next, connect the black ballast wire to the hot supply wire and the white ballast wire to the common supply wire. Install cover on junction box.

Step 8. Install lamps in fixture. Use maximum 100 watt incandescent lamps or Fluorescent Lamp Medium Base maximum 20 watt. Use only GX24q-3 Base, 26W 4-Pin Lamp in Compact Fluorescent Light Add-on Kit as specified on UL Label on lamp bracket.

NOTE: Solatube International recommends the use of fluorescent bulbs with the Incandescent Light Add-On Kit in cold weather climates to reduce condensation build up resulting from the heat produced by incandescent bulbs.

NOTE: The Solatube warranty and UL rating void if not installed in a Solatube 160 DS or 290 DS product according to manufacturer's installation instructions.

You may now enjoy the convenience of the Solatube Light Add-On Kit, in addition to your Solatube Daylighting System.



Solatube International, Inc.

2210 Oak Ridge Way, Vista, CA 92081-8341
Phone (888) 765-2882 • Fax (760) 599-5181
www.solatube.com

WARNING: BALLAST MAY NOT CONTACT COMBUSTIBLE MATERIAL

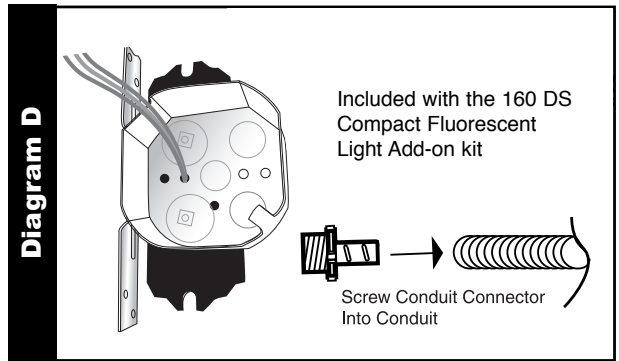

INCANDESCENT LIGHT

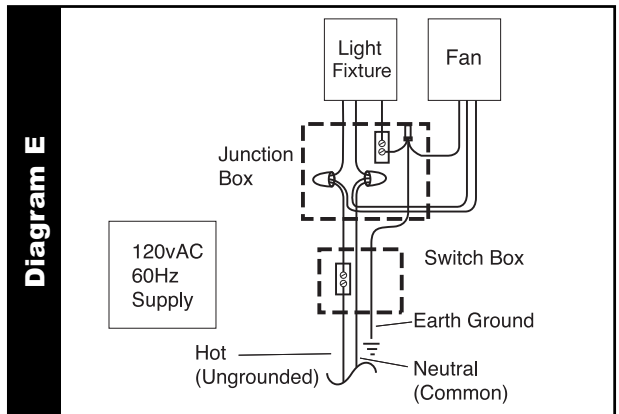

26 WATT COMPACT FLUORESCENT

